

CONQUER-T

Rayspot Aydınlatma / Track Light

Ürün Kodu / Product Code: SP2210132-XXX830W

Özellikler

- Özel tasarım soğutucu gövde sayesinde yüksek termal dayanım ve uzun ömür
- Alüminyum enjeksiyon soğutucu gövde, çerçeve, arka kapak ve mafsalları
- Beyaz(RAL 9016) renkli elektrostatik toz boya
- Yüksek ışık geçirgenliğine sahip temperli cam
- Yüksek verimlilikte saf alüminyum reflektör
- Armatür yatay ekseninde 350° ve dikey ekseninde 90 ° yönlendirilebilir
- 3-faz ayarlı dahili sürücülü ray adaptörü

Specifications

- High thermal strength and long life due to specially designed heatsink body
- Die-cast aluminium housing, frame, end cap and bracket
- Electrostatic powder coated with white(RAL 9016) colour
- Extra clear tempered glass
- High efficiency pure aluminium reflector
- Luminaire can rotate through 350° and tilt through 90°
- With 3-phase track-in driver

Teknik Veriler / Technical Data

Sistem gücü / System power * (Watt)	32
Armatür lümeni / Luminaire luminous flux* (Lumen)	3680
Armatür etkinliği / Luminaire efficacy* (lm/W)	115
Renkssel geri verim(CRI) / Colour rendering index (CRI)	80
Renk sıcaklığı / Correlated Colour temperature * (Kelvin)	3000
Işık Açısı / Beam Angle (Degree)	45
Enerji sınıfı / Energy class	D
Giriş gerilimi / Input voltage	220-240 V / 50-60 Hz
Güç faktörü/ Power factor	0,9
LED ömrü (LED üretici verisi) / Lumen maintenance*	L80 B10 50.000 saat / hours
(LED manufacturer specifications)	(tc 65 °C)
Renk toleransı / Colour deviation	≤3
Fotobiyolojik güvenlik sınıfı / Photobiological safety	RG1
Armatür kontrolü / Luminaire control	Aç-kapa / On-off



650 °C



220-240V
50-60 Hz

Teknik Çizim / Technical Drawing

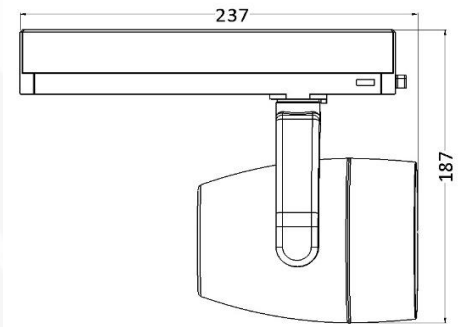

Seçenekler

- Siyah, gri veya özel renk seçeneği elektrostatik toz boya
- Dar, orta veya geniş ışık çıkış açısı
- 80 CRI veya 90 CRI
- 2700K , 3000K veya 4000K renk sıcaklığı
- 1-10 V ve DALI seçenekleri
- Bal peteği difüzör

Options

- Electrostatic powder coated with black, grey or special colour
- Narrow, medium or wide beam angle
- 80 CRI or 90 CRI
- 2700K , 3000K or 4000K color temperature
- 1-10 V and DALI options
- Honeycomb diffuser

Veriler içerisinde * ile işaretlenen tüm değerler ortalama değerlerdir. Sistem gücü +/- 10 % ilk tolerans ve armatür lümeni +/- 4 % tolerans içerisinde. Renk sıcaklığının toleransı +/- 150 K'dir. Aksi belirtilmedikçe verilen tüm değerler için ortam sıcaklığı 25 °C'dir.

Values marked with * are rated values. System power is subject to an initial tolerance of +/- 10 % and luminaire luminous flux is subject to a tolerance of +/- 4 % . Tolerance of colour temperature is +/- 150 K. Unless stated otherwise, the values apply to an ambient temperature of 25 °C.



EN 60598-2-1